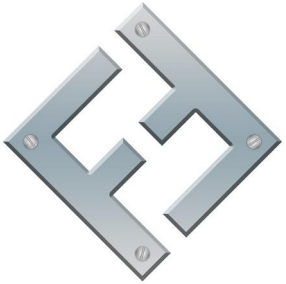

DRAWN Dione		07/04/2015		FAZ FORTE RESERVATORIOS METALICOS	
 FAZFORTE		PADRAO TQV 301			
		SIZE C	DWG NO TQV 301		REV
SCALE				SHEET 1 OF 5	

4

3

2

1

D

D

C

C

B

B

A

A

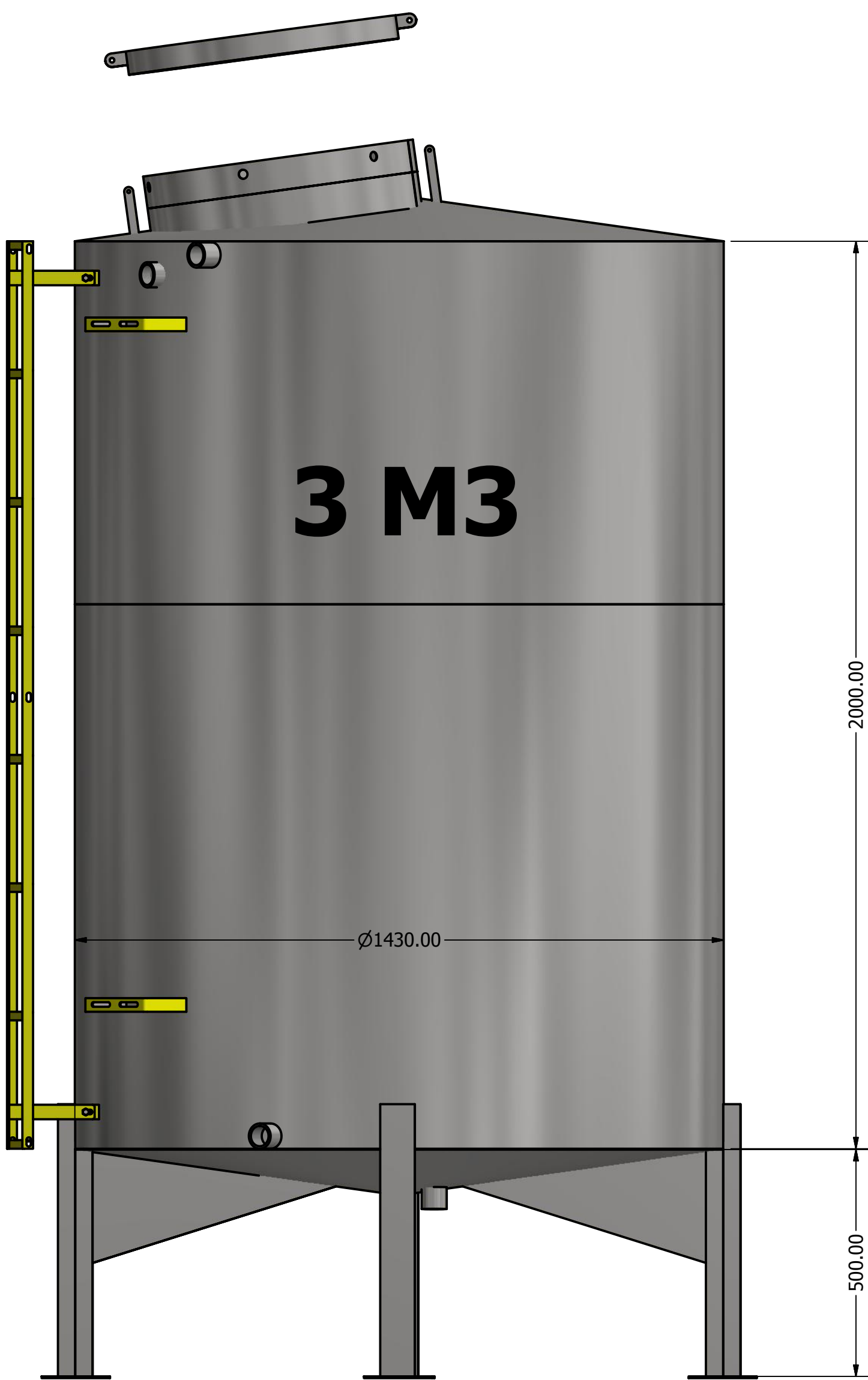

LISTA DE PEÇAS		
ITEM	QTD	NÚM. DE PEÇA
1	1	TQV 301 CASCA
2	1	tampa inspeção
3	1	ESCADA 2 METROS
4	2	suporte tubolação
5	4	ISO 4144 - Bolsa S2 1 1/2
6	1	

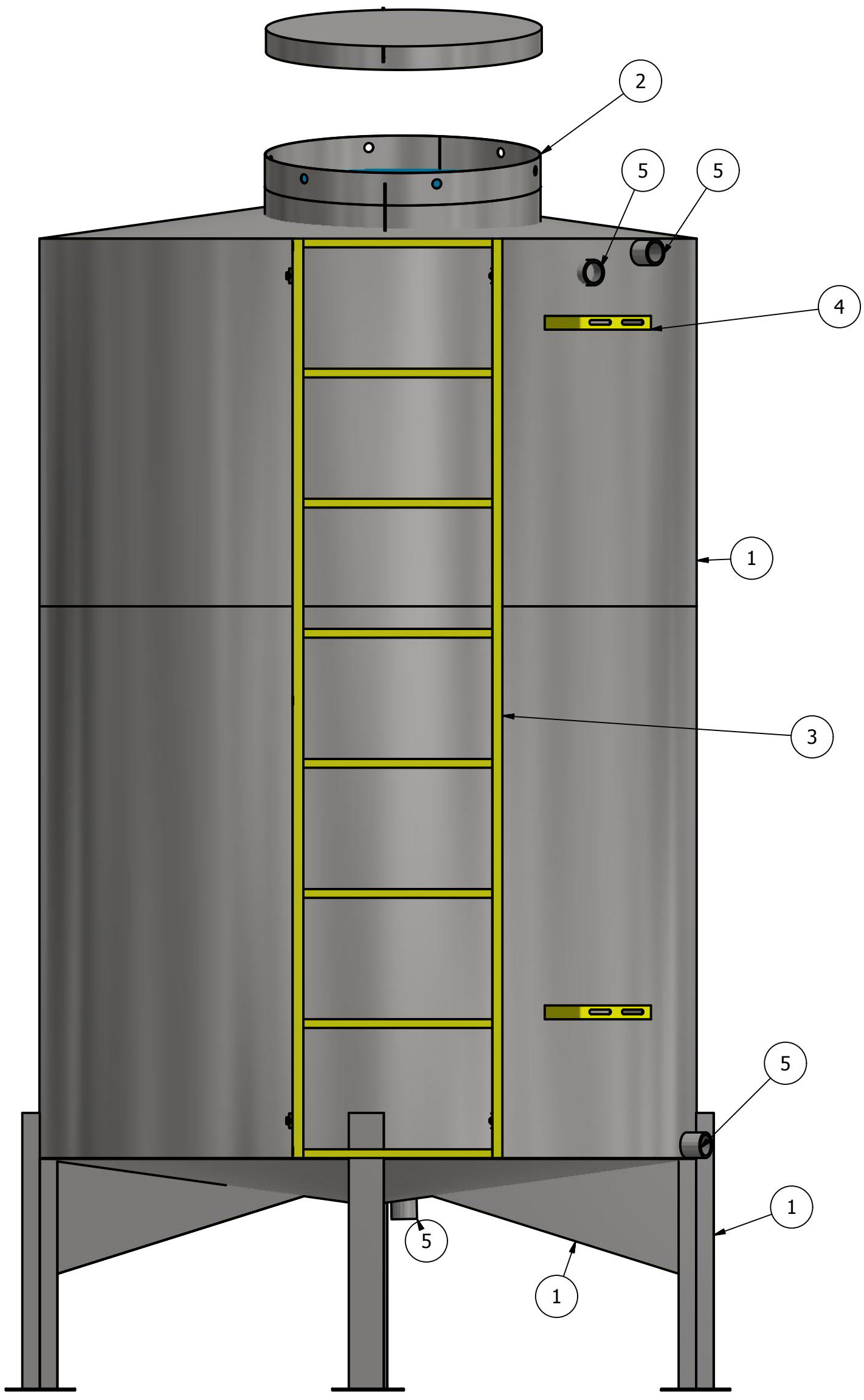

VIGA U LAMINADA 3" #3.75

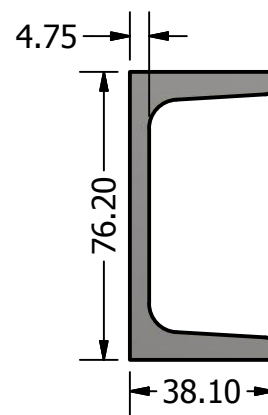
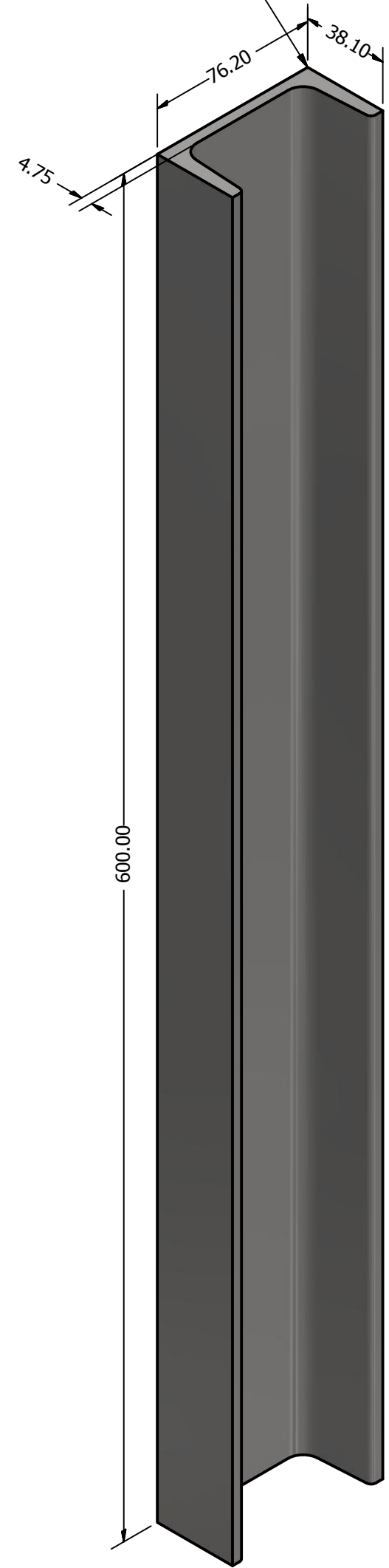
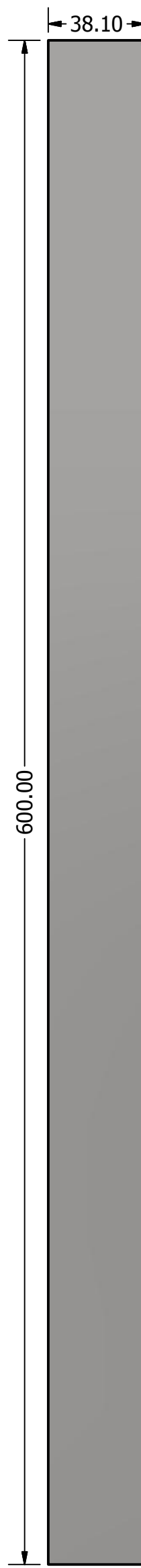
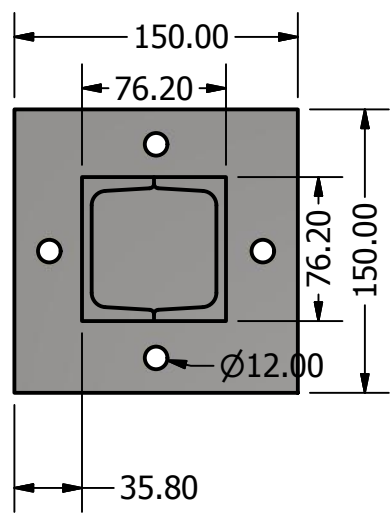
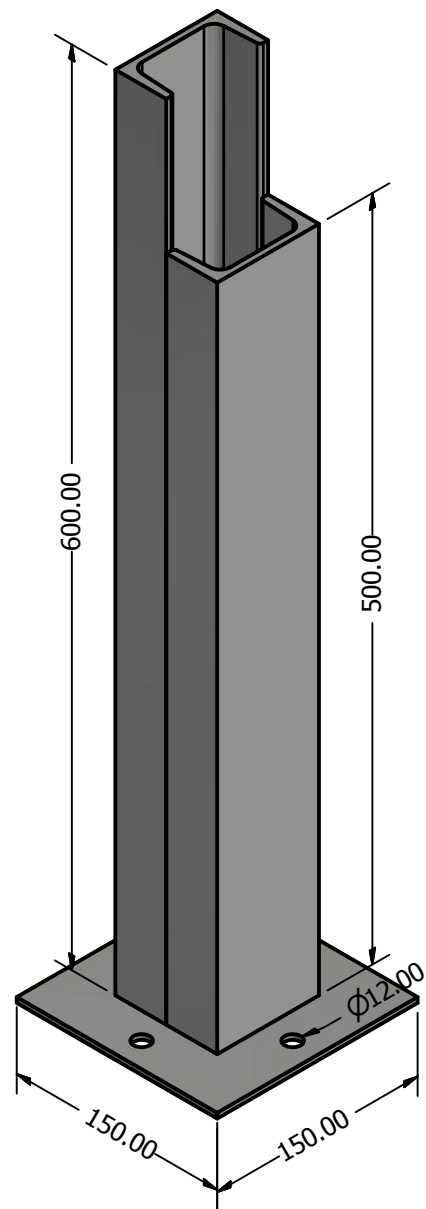
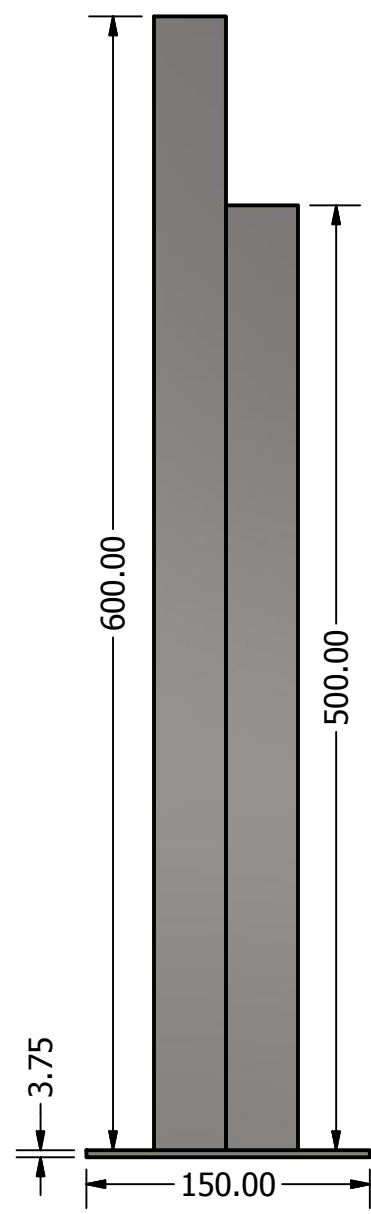

4

3

2

1

D

D

C

C

B

B

A

A

4

3

2

1