

EXTRAVASOR 1 1/2"

ENTRADA 1 1/2"

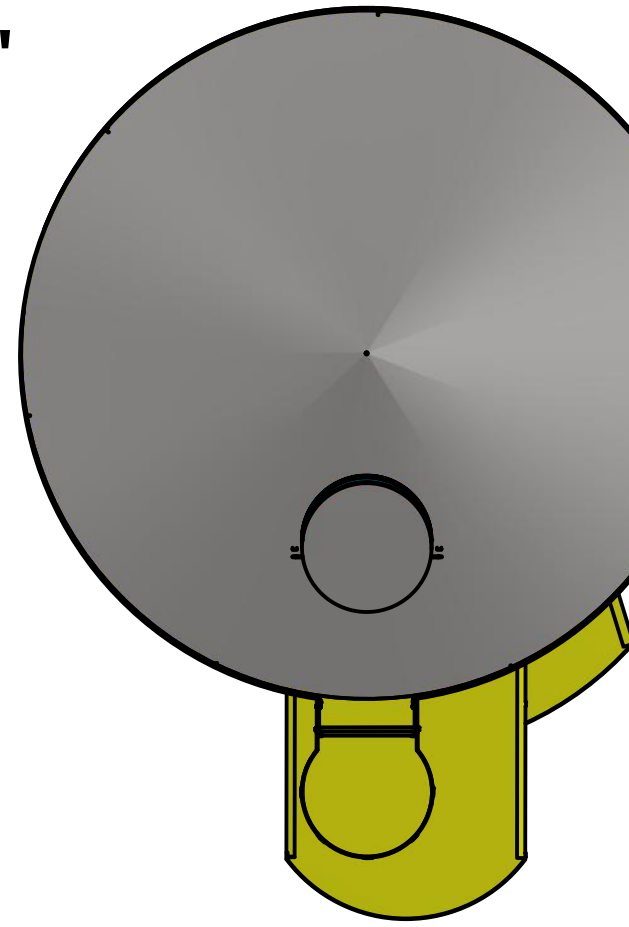

ENTRADA 1 1/2"

EXTRAVASOR 1 1/2"

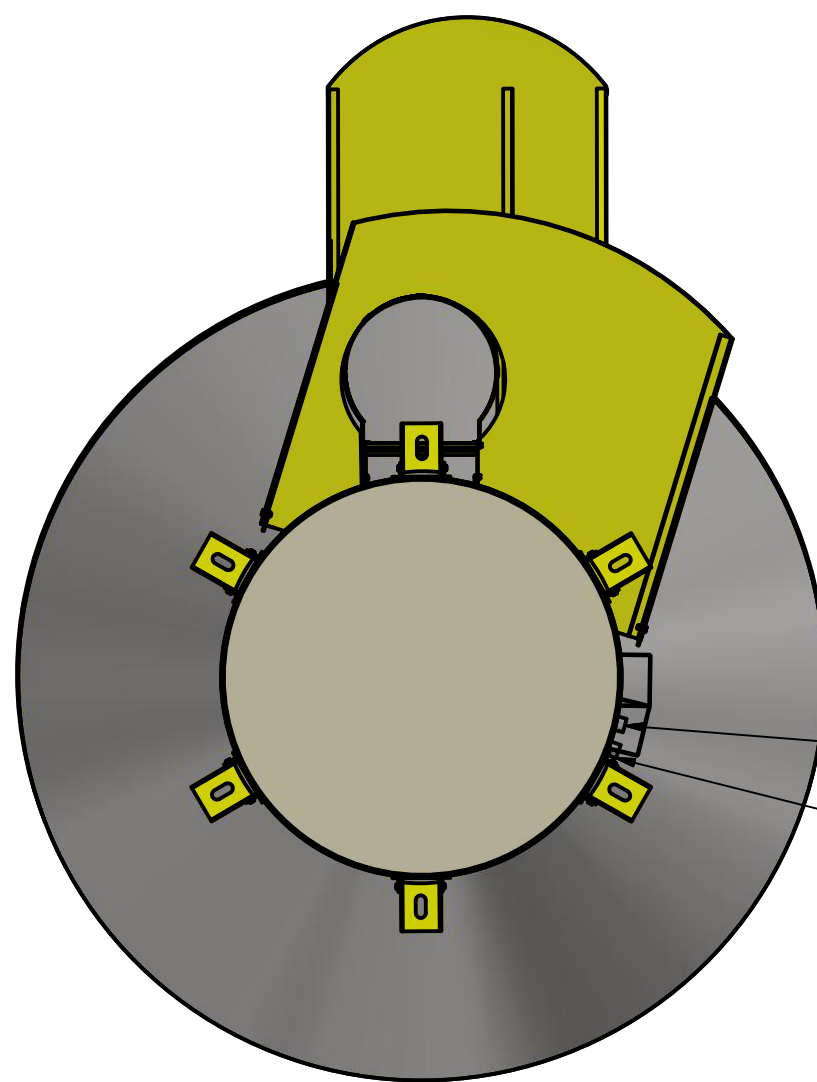

EXTRAVASOR 1 1/2"

ENTRADA 1 1/2"

SAIDA 1 1/2"

DRENO 1 1/2"

DRAWN
Jander Dantas 07/04/2015

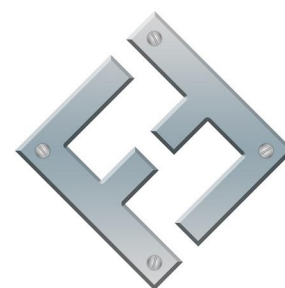

FAZFORTE

FAZ FORTE RESERVATORIOS METALICOS

PADRAO

TCS 7003

SIZE C	DWG NO TCS 7003	REV
SCALE	SHEET 1 OF 4	

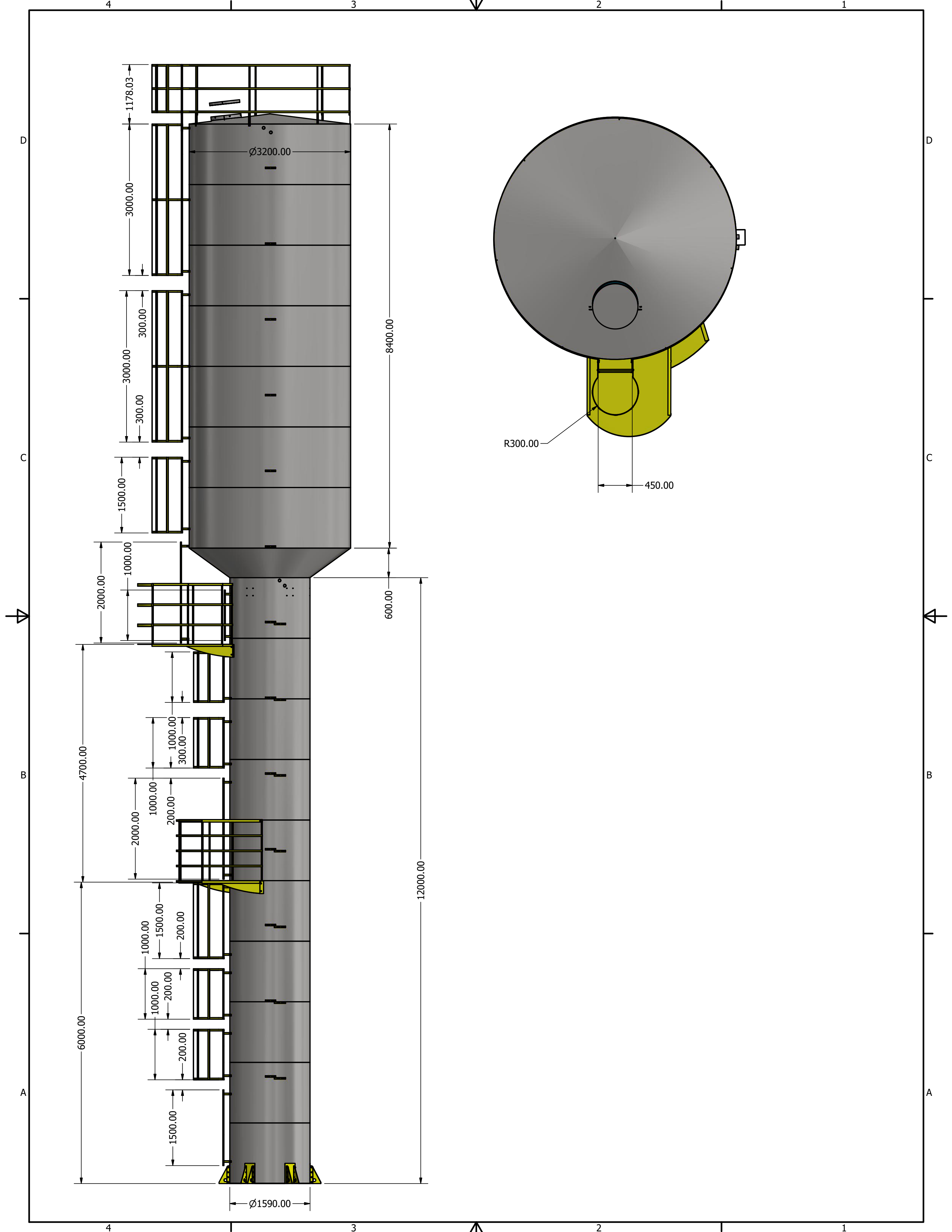

4

3

2

1

D

D

C

C

B

B

A

A

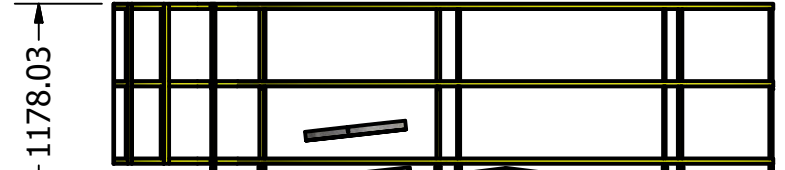

1178.03

Ø3200.00

3000.00

3000.00

3000.00

3000.00

300.00

300.00

1500.00

1000.00

2000.00

1000.00

1000.00

2000.00

1000.00

1500.00

1000.00

1000.00

200.00

1500.00

8400.00

300.00

300.00

600.00

12000.00

Ø1590.00

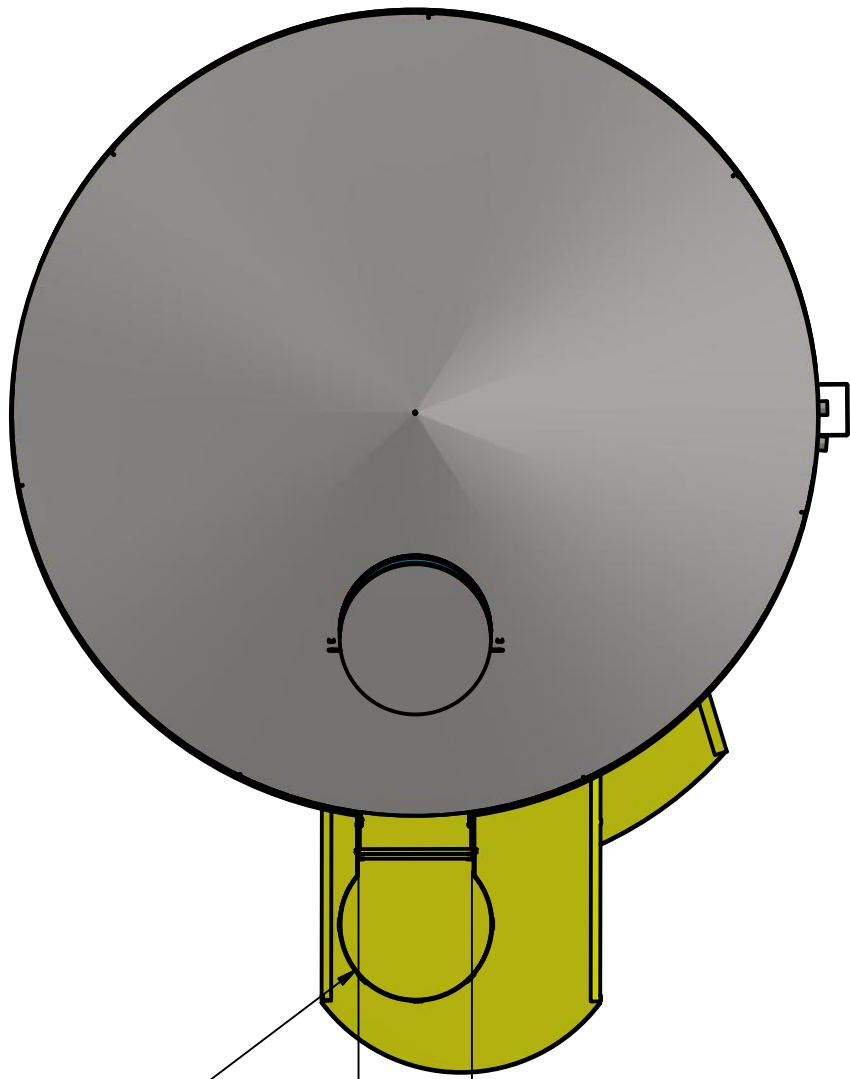

R300.00

450.00



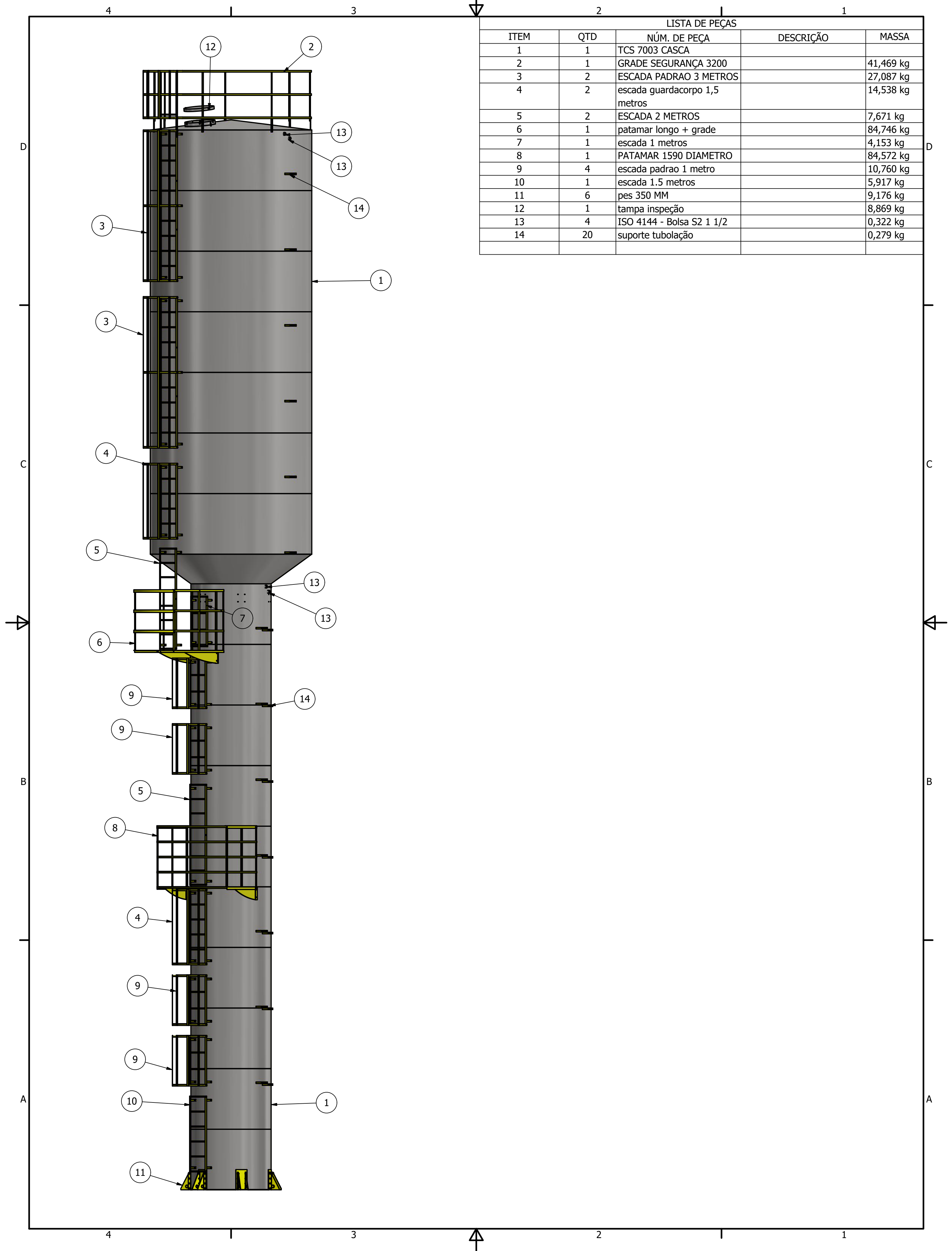

LISTA DE PEÇAS				
ITEM	QTD	NÚM. DE PEÇA	DESCRIÇÃO	MASSA
1	1	TCS 7003 CASCA		
2	1	GRADE SEGURANÇA 3200		41,469 kg
3	2	ESCADA PADRAO 3 METROS		27,087 kg
4	2	escada guardacorpo 1,5 metros		14,538 kg
5	2	ESCADA 2 METROS		7,671 kg
6	1	patamar longo + grade		84,746 kg
7	1	escada 1 metros		4,153 kg
8	1	PATAMAR 1590 DIAMETRO		84,572 kg
9	4	escada padrao 1 metro		10,760 kg
10	1	escada 1.5 metros		5,917 kg
11	6	pes 350 MM		9,176 kg
12	1	tampa inspeção		8,869 kg
13	4	ISO 4144 - Bolsa S2 1 1/2		0,322 kg
14	20	suporte tubolação		0,279 kg