

4

3

2

1

D

D

C

C

B

B

A

A

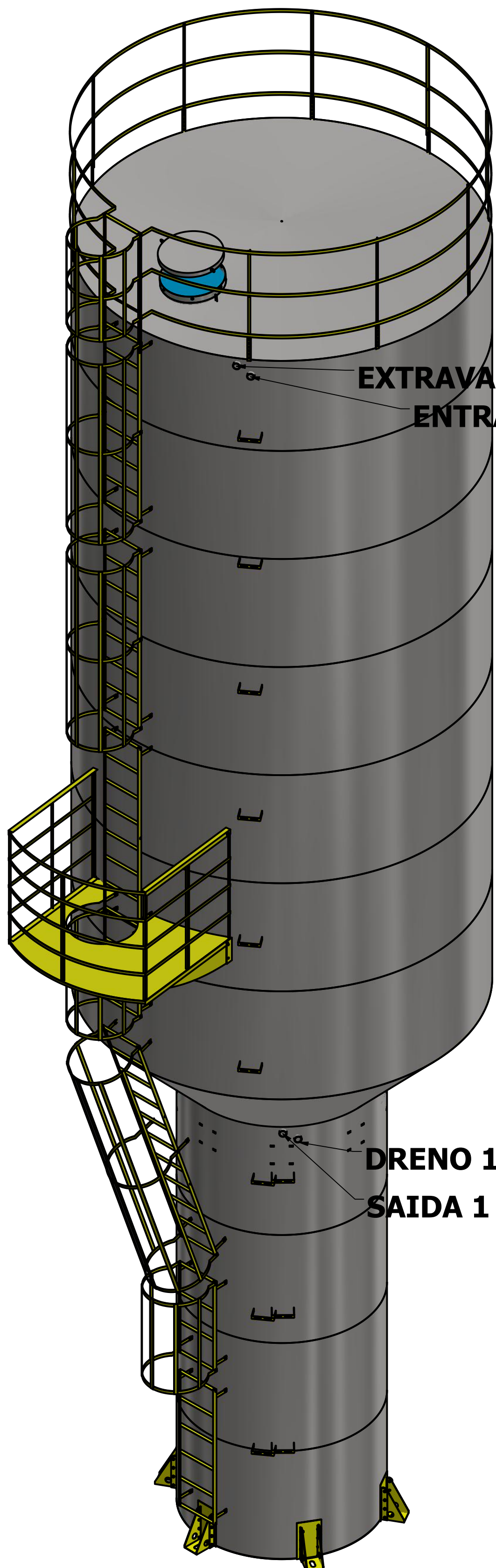

EXTRAVASOR 1 1/2"
ENTRADA 1 1/2"

DRENO 1 1/2"
SAIDA 1 1/2"

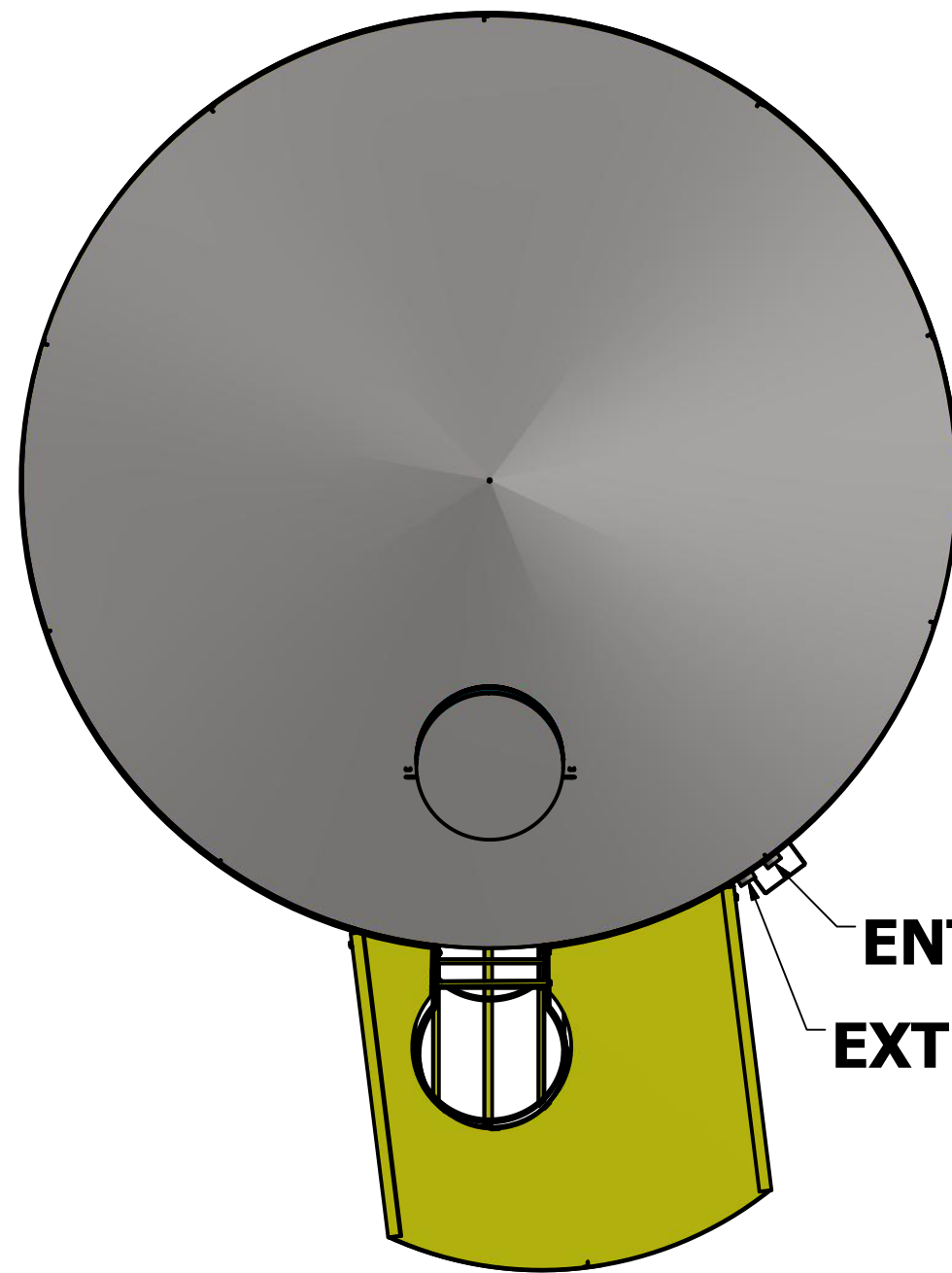

ENTRADA 1 1/2"
EXTRAVASOR 1 1/2"

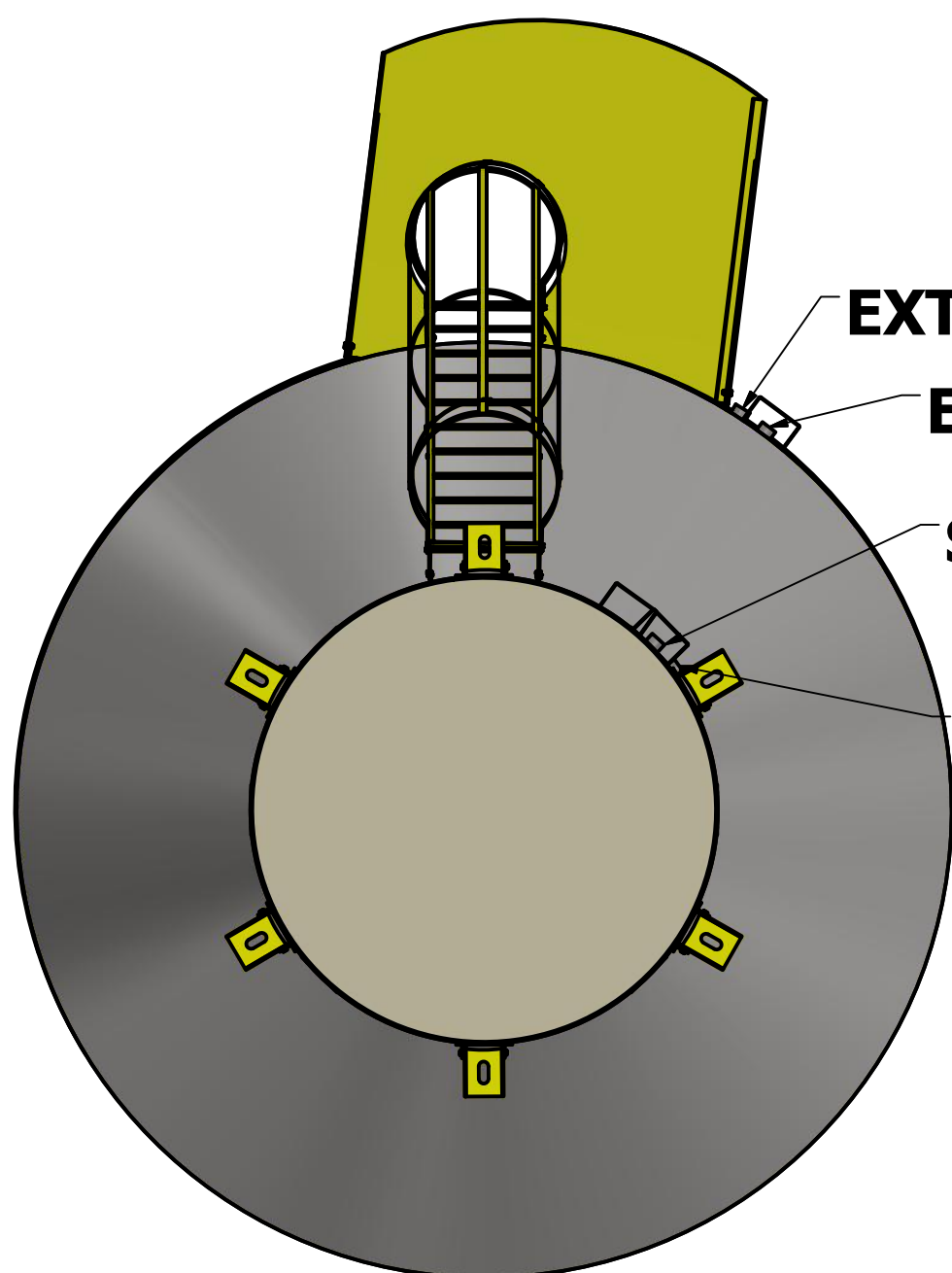

EXTRAVASOR 1 1/2"
ENTRADA 1 1/2"

SAIDA 1 1/2"

DRENO 1 1/2"

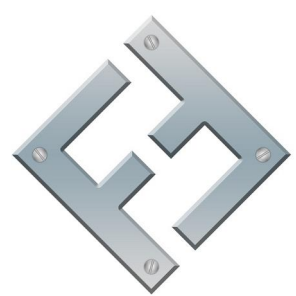
PROJETA DIONE RODRIGUES		FAZ FORTE RESERVATORIOS METALICOS	
		PADRAO TCS 10001 PESO:6722,858 kg	
SIZE C	DWG NO TCS 10001	REV	
SCALE		SHEET 1 OF 4	

4

3

2

1

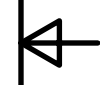
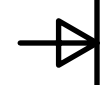

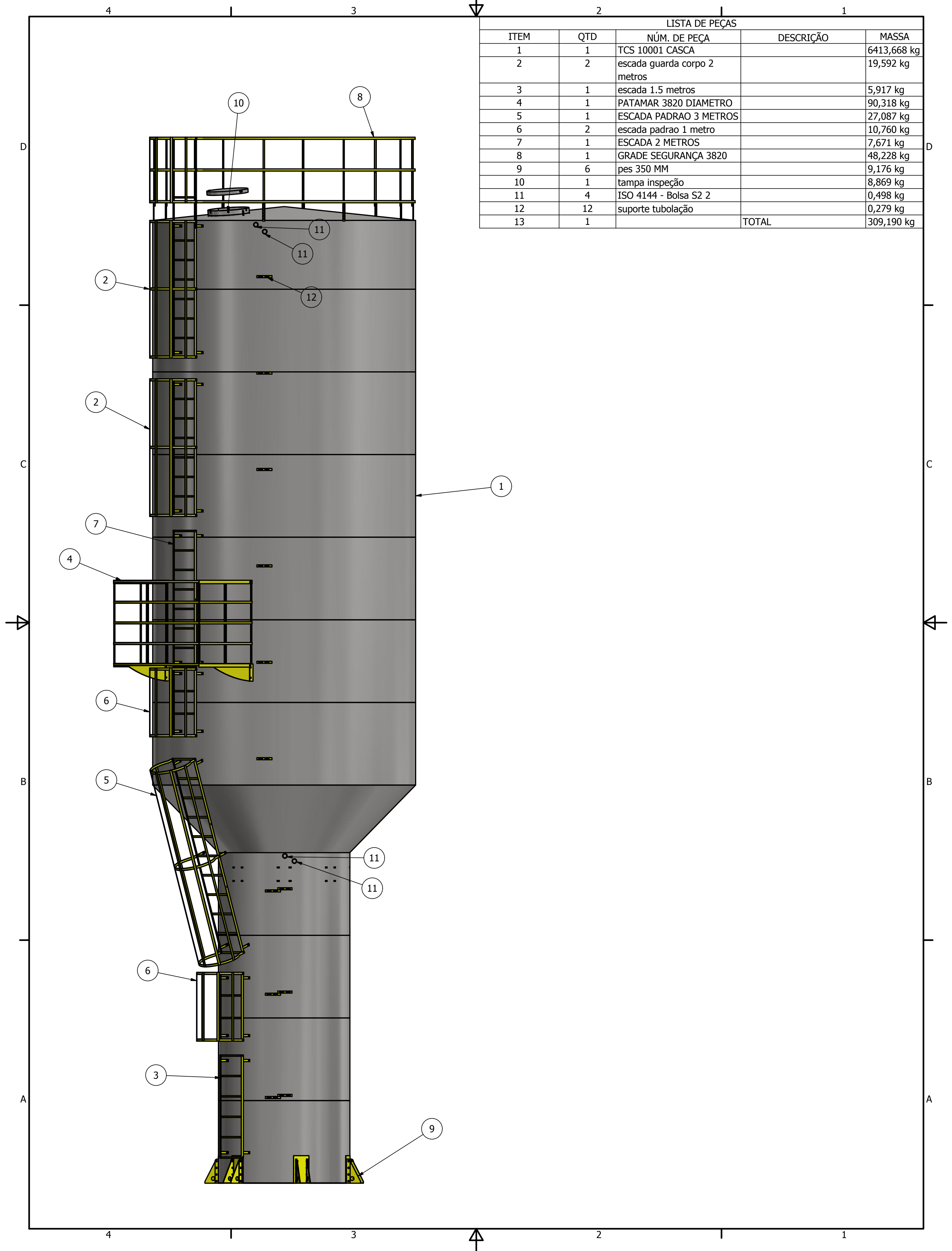

LISTA DE PEÇAS				
ITEM	QTD	NÚM. DE PEÇA	DESCRIÇÃO	MASSA
1	1	TCS 10001 CASCA		6413,668 kg
2	2	escada guarda corpo 2 metros		19,592 kg
3	1	escada 1.5 metros		5,917 kg
4	1	PATAMAR 3820 DIAMETRO		90,318 kg
5	1	ESCADA PADRAO 3 METROS		27,087 kg
6	2	escada padrao 1 metro		10,760 kg
7	1	ESCADA 2 METROS		7,671 kg
8	1	GRADE SEGURANÇA 3820		48,228 kg
9	6	pes 350 MM		9,176 kg
10	1	tampa inspeção		8,869 kg
11	4	ISO 4144 - Bolsa S2 2		0,498 kg
12	12	suporte tubulação		0,279 kg
13	1		TOTAL	309,190 kg