

EXTRAVASOR 1 1/2"

ENTRADA 1 1/2"

DRENO 1 1/2"
SAIDA 1 1/2"
EXTRAVASOR 1 1/2"
ENTRADA 1 1/2"

DRENO 1 1/2"

SAIDA 1 1/2"

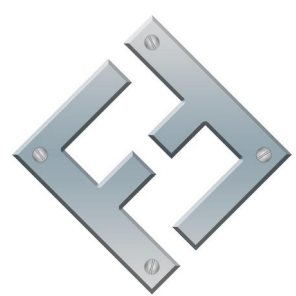
| | | | | | |
|--|-------------------|------------|--------------|-----------------------------------|--|
| DRAWN Dione | | 07/04/2015 | | FAZ FORTE RESERVATORIOS METALICOS | |
|  FAZFORTE | | | | | |
| TITLE TBL 8001 | | | | | |
| SIZE C | DWG NO TBL8001 | | REV | | |
| SCALE | | | SHEET 1 OF 4 | | |

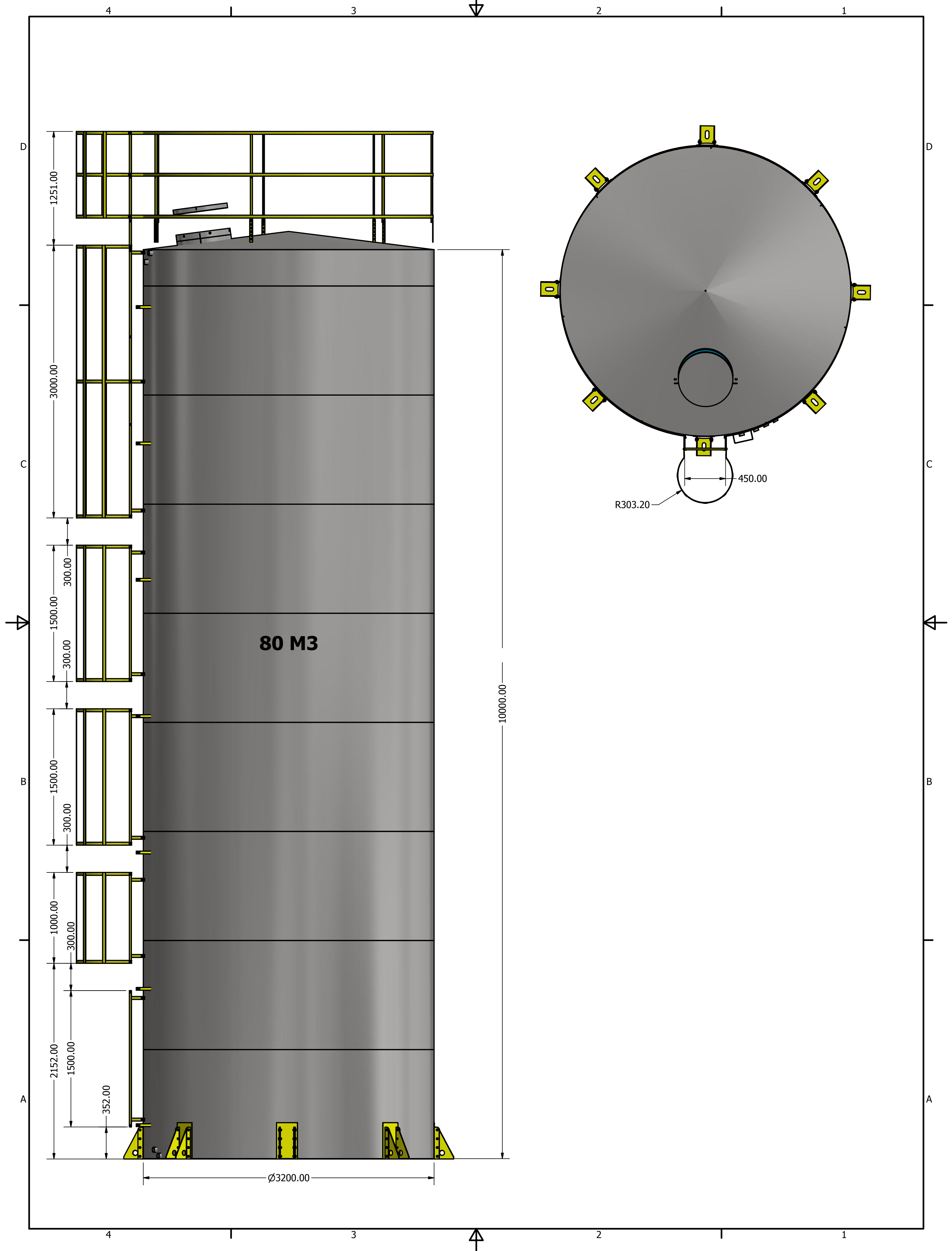

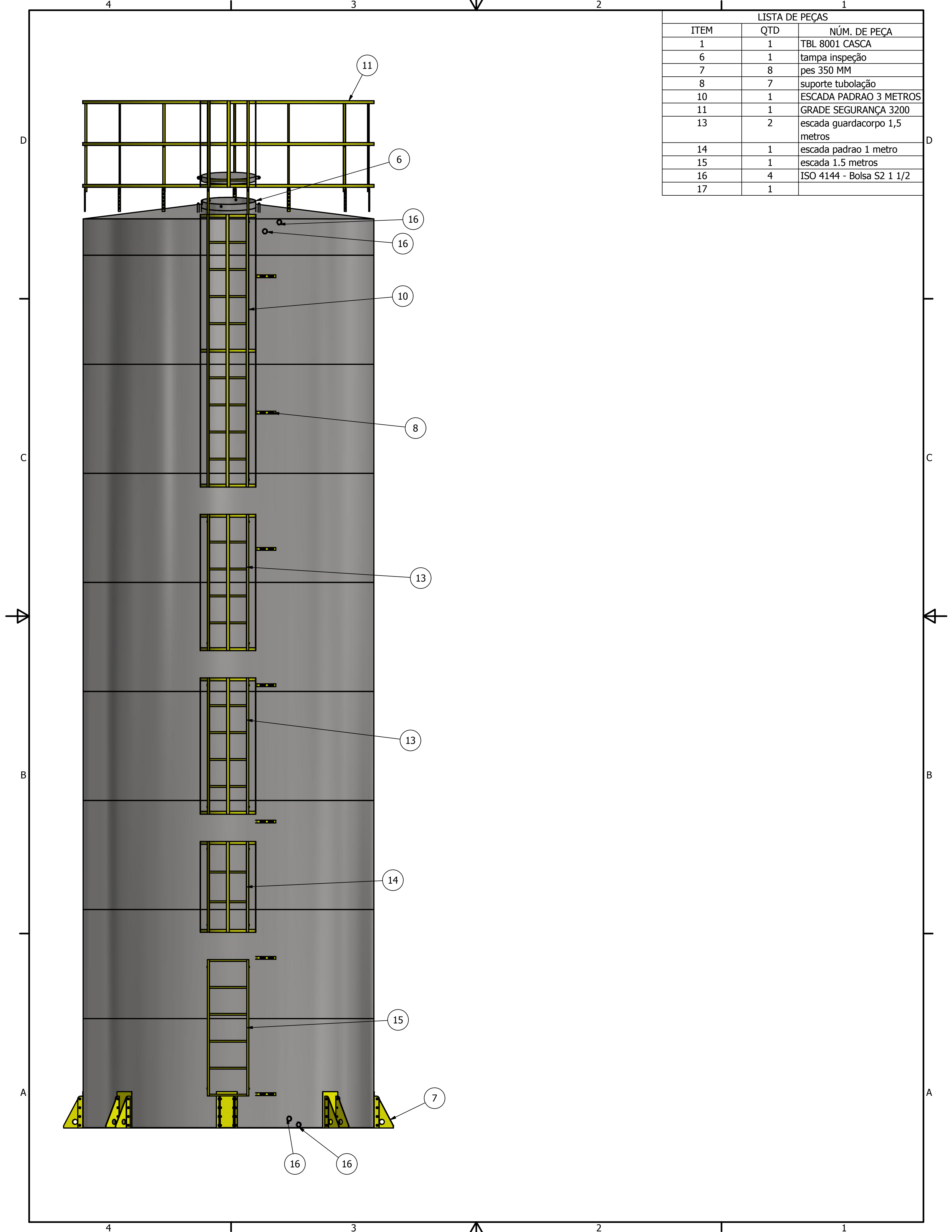

| LISTA DE PEÇAS | | |
|----------------|-----|-------------------------------|
| ITEM | QTD | NÚM. DE PEÇA |
| 1 | 1 | TBL 8001 CASCA |
| 6 | 1 | tampa inspeção |
| 7 | 8 | pes 350 MM |
| 8 | 7 | suporte tubulação |
| 10 | 1 | ESCADA PADRAO 3 METROS |
| 11 | 1 | GRADE SEGURANÇA 3200 |
| 13 | 2 | escada guardacorpo 1,5 metros |
| 14 | 1 | escada padrao 1 metro |
| 15 | 1 | escada 1.5 metros |
| 16 | 4 | ISO 4144 - Bolsa S2 1 1/2 |
| 17 | 1 | |