

EXTRAVASOR 1 1/2"

ENTRADA 1 1/2"

DRENO 1 1/2"
SAÍDA 1 1/2"

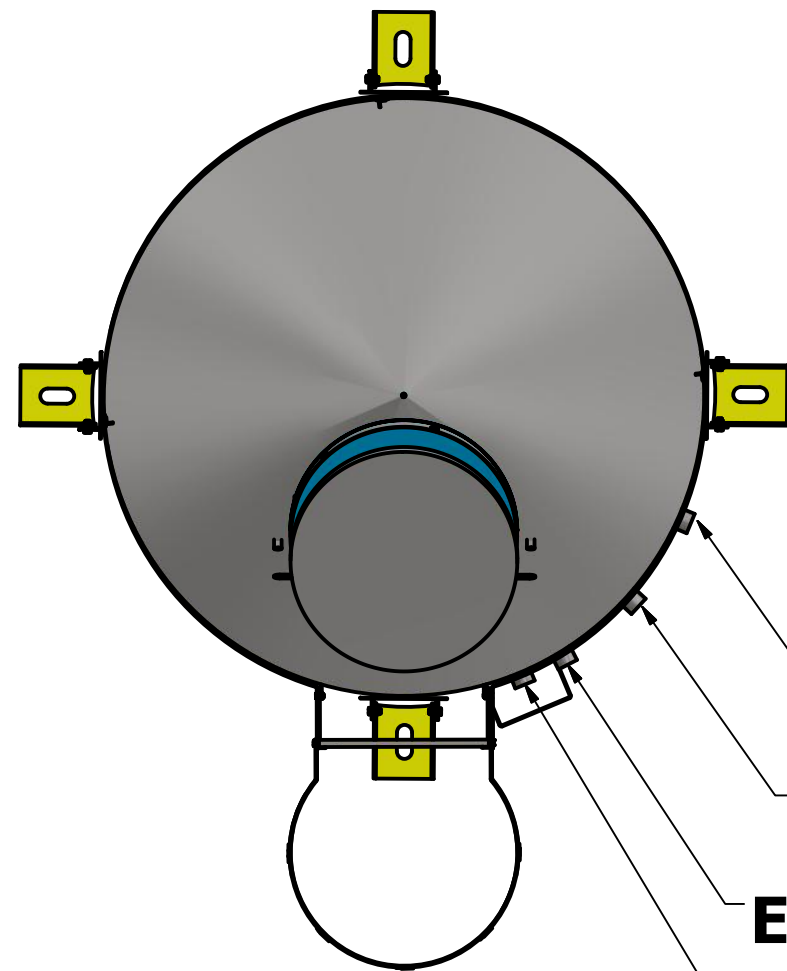

DRENO 1 1/2"
SAÍDA 1 1/2"
EXTRAVASOR 1 1/2"
ENTRADA 1 1/2"

DRAWN
Gabriel Moretti 01/03/2017



FAZ FORTE RESERVATORIOS METALICOS

TITLE

TBL 2002

PADRAO

SIZE

C

DWG NO

TBL 2002

REV

SCALE

SHEET 1 OF 4

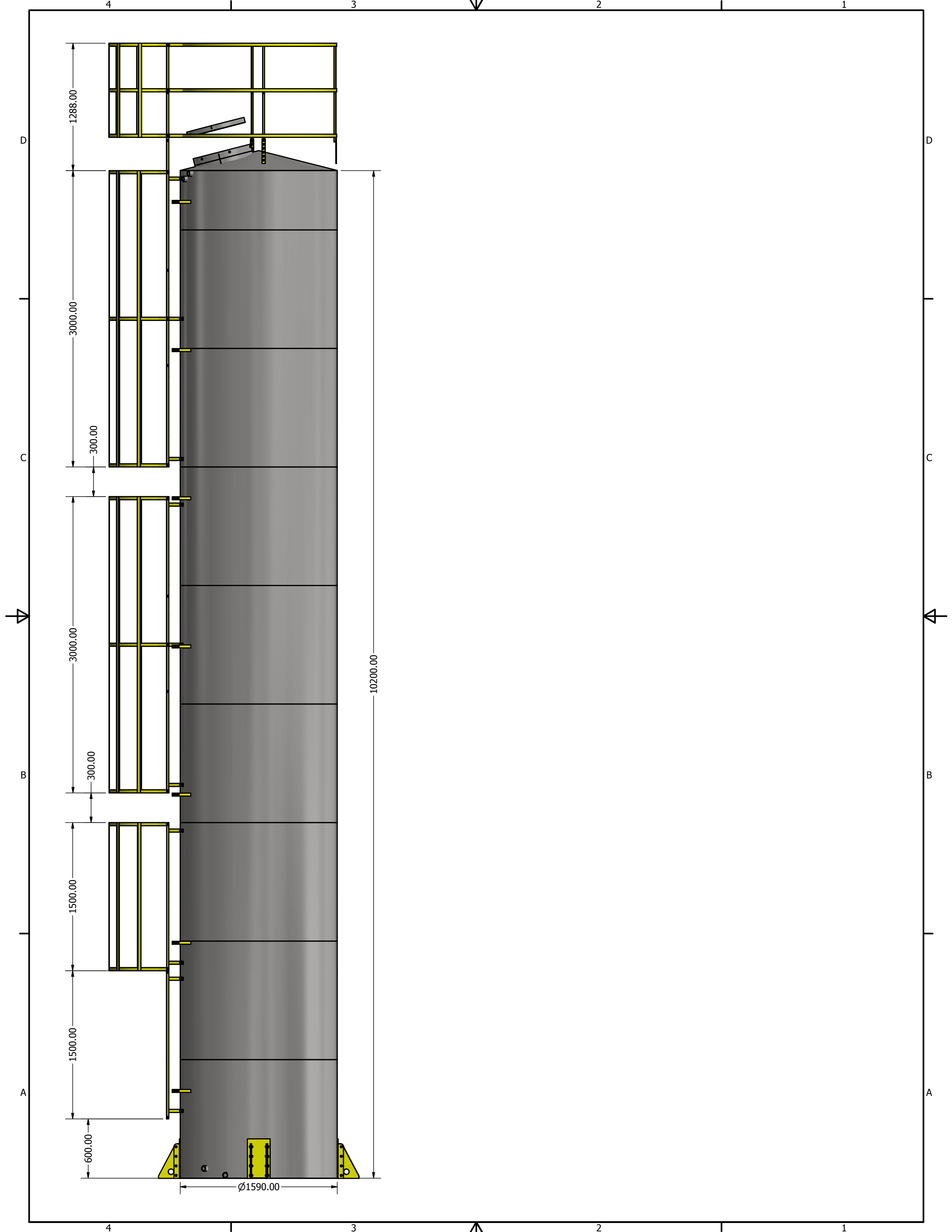

4

1

3

2

1

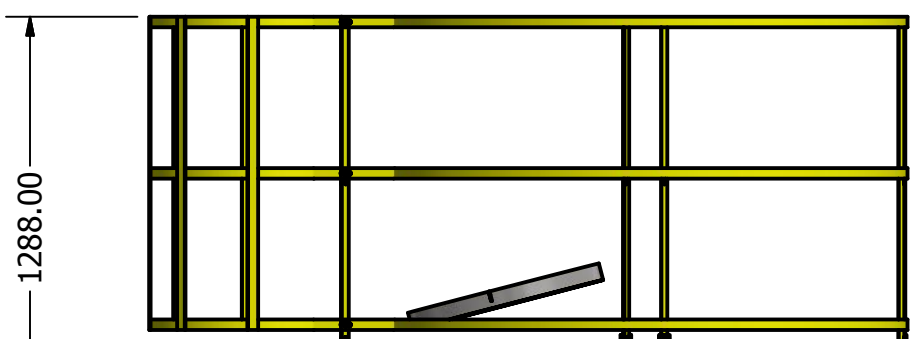

1288.00

D

D

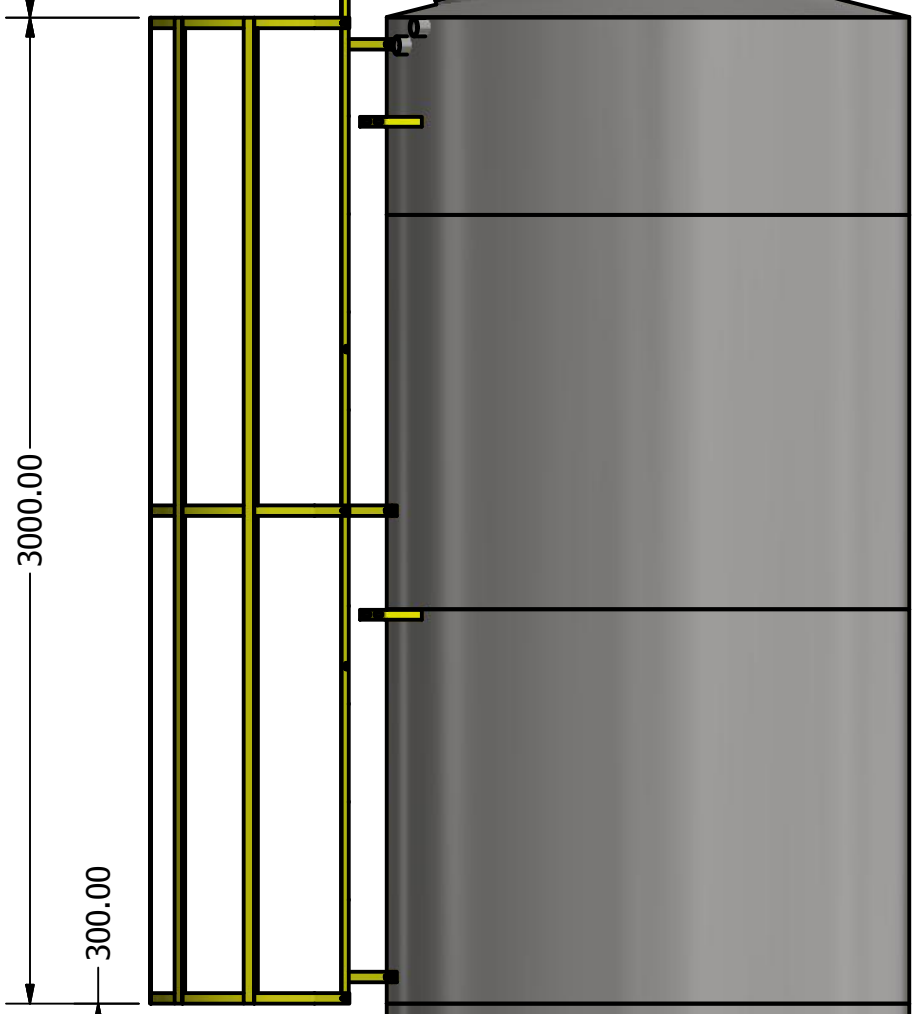

3000.00

C

C

300.00

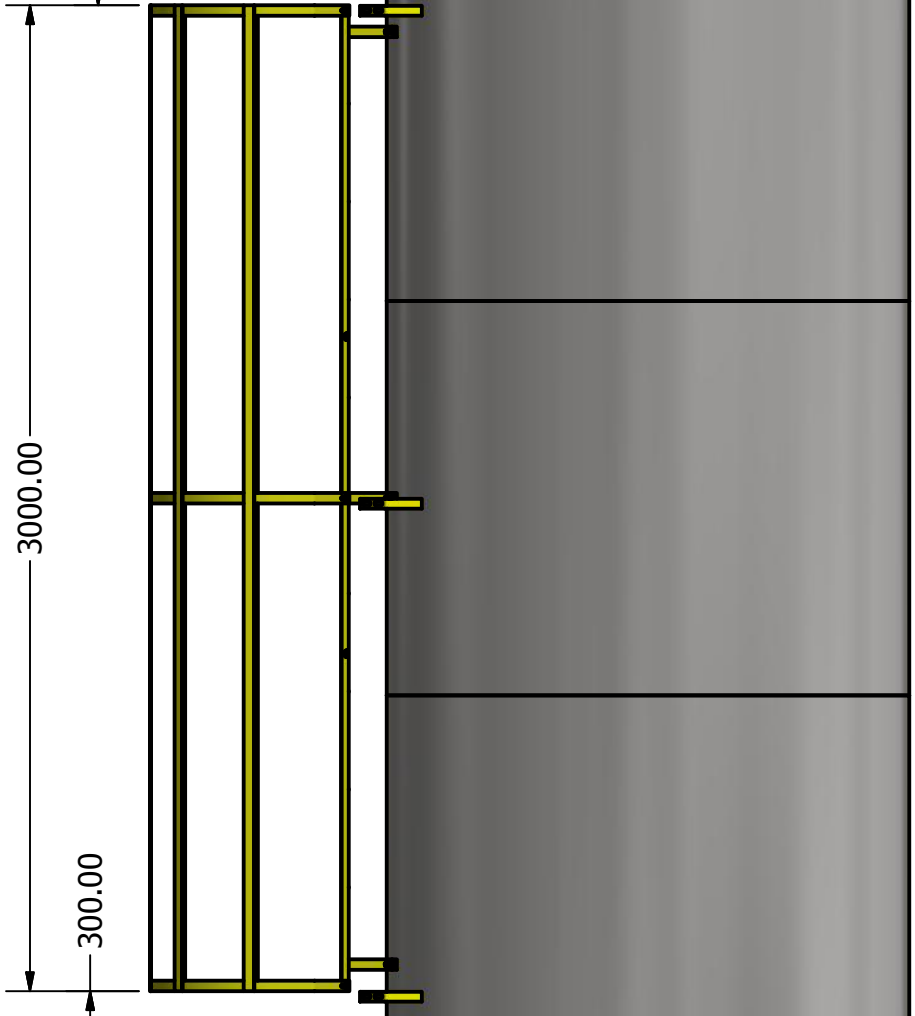

3000.00

B

B

300.00

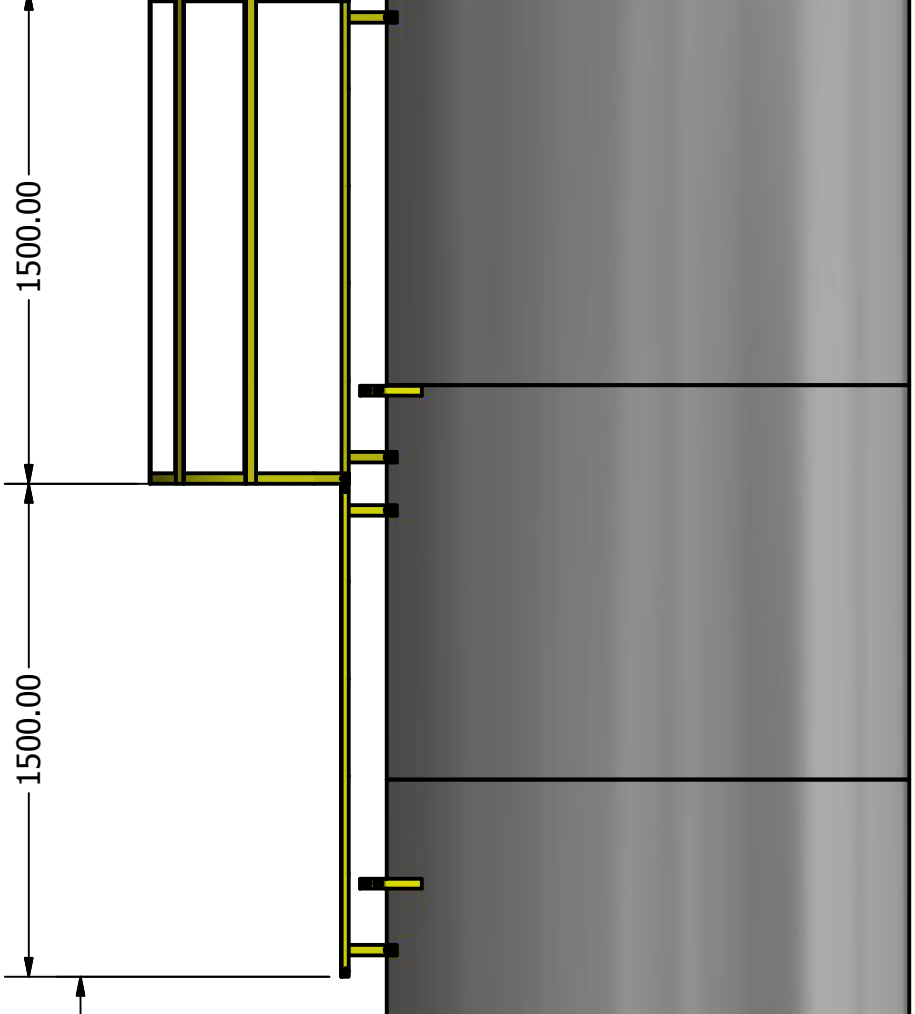

1500.00

A

A

300.00

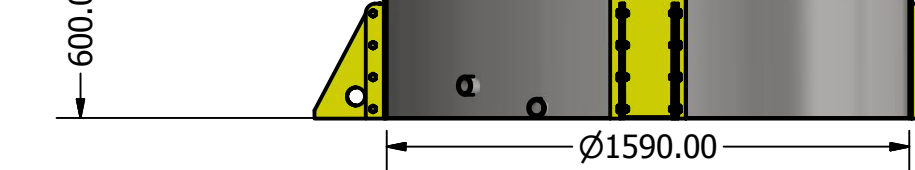

600.00

Ø1590.00

10200.00

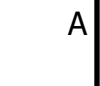
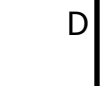

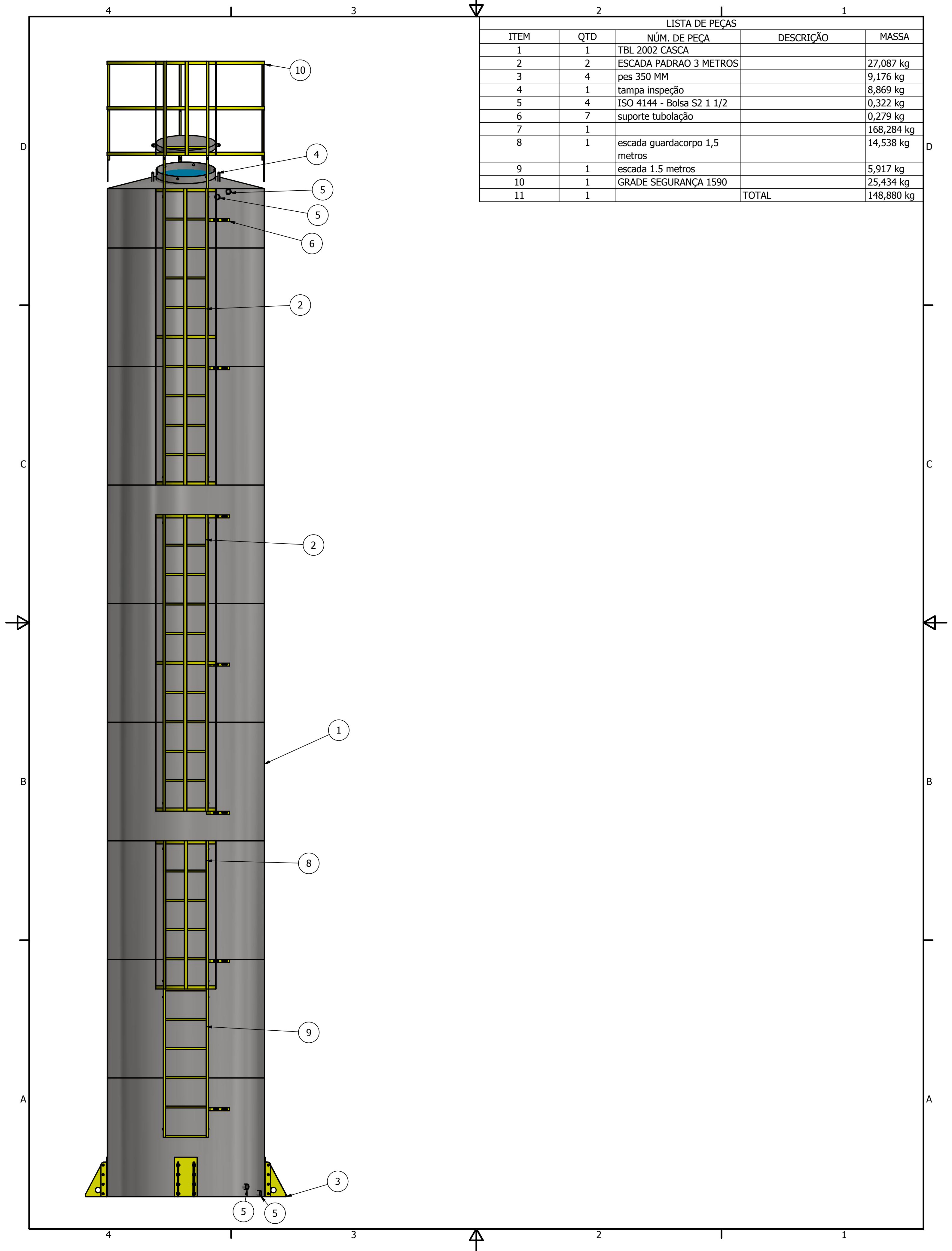

LISTA DE PEÇAS				
ITEM	QTD	NÚM. DE PEÇA	DESCRIÇÃO	MASSA
1	1	TBL 2002 CASCA		
2	2	ESCADA PADRAO 3 METROS		27,087 kg
3	4	pes 350 MM		9,176 kg
4	1	tampa inspeção		8,869 kg
5	4	ISO 4144 - Bolsa S2 1 1/2		0,322 kg
6	7	suporte tubulação		0,279 kg
7	1			168,284 kg
8	1	escada guardacorpo 1,5 metros		14,538 kg
9	1	escada 1.5 metros		5,917 kg
10	1	GRADE SEGURANÇA 1590		25,434 kg
11	1		TOTAL	148,880 kg